

English

This is me

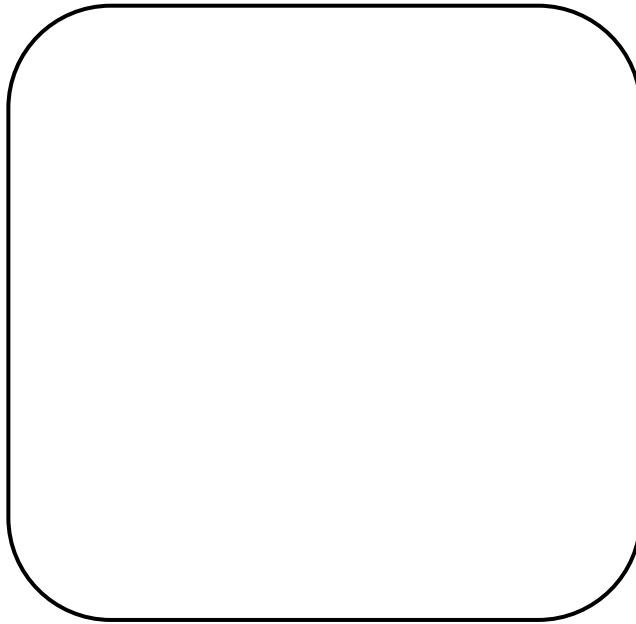

My name is

I am a

(boy / girl)

I am

years old.

My Father's name is

My Mother's name is

I study in class

The name of my school is

With the clue in checkbox :

See with my

I smell with my

I kick a ball with my

I use my

to taste

I hear with

My mother puts her bindi on

When I eat my favourite food my

is full .

There must always be a smile on your

(ear, eyes, face, nose, foot, forehead, tongue, stomach)

Write the names of 6 things that help us to keep our body and home clean Also paste their pictures.

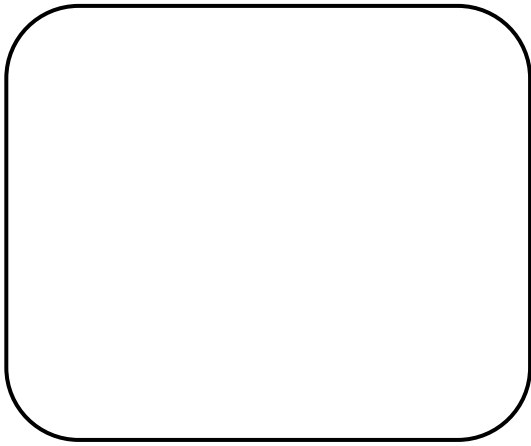

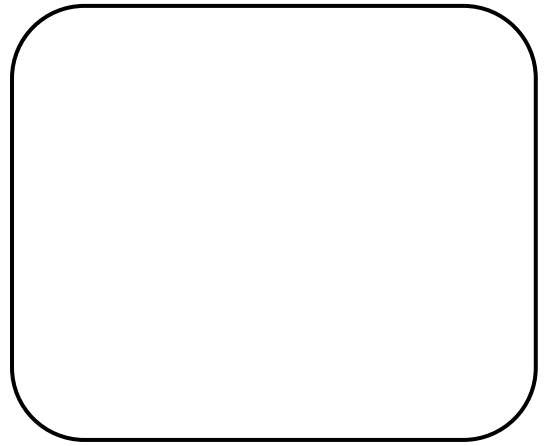

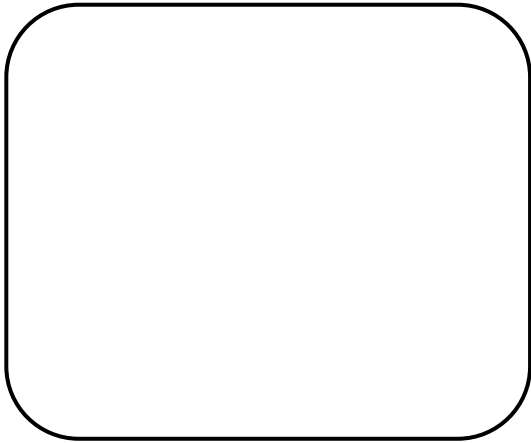

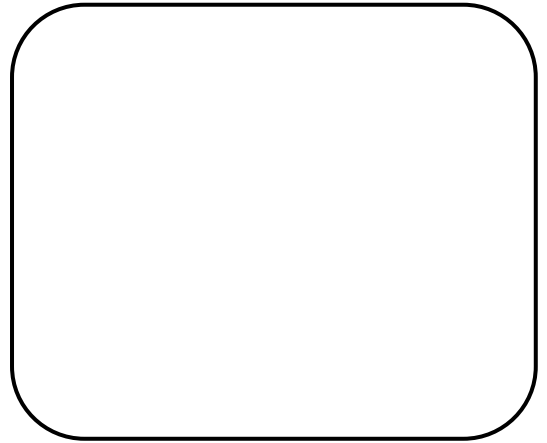

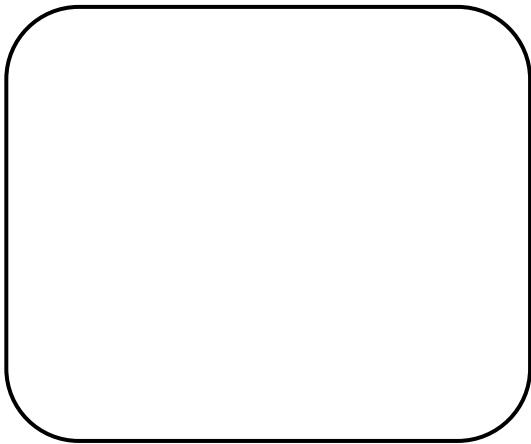

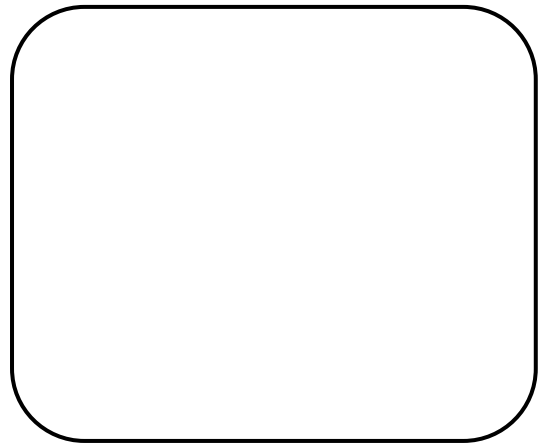

Write 'YES' on good habit & 'No' on bad habit :

1. Respect your elders

2. Brush your teeth once a week

3. Throw garbage on road

4. Take bath daily

5. Wash hands after and before every meal

6. Do not wash fruits before eating

7. Get up early in morning

8. Never exercise

“kCn cukb, &

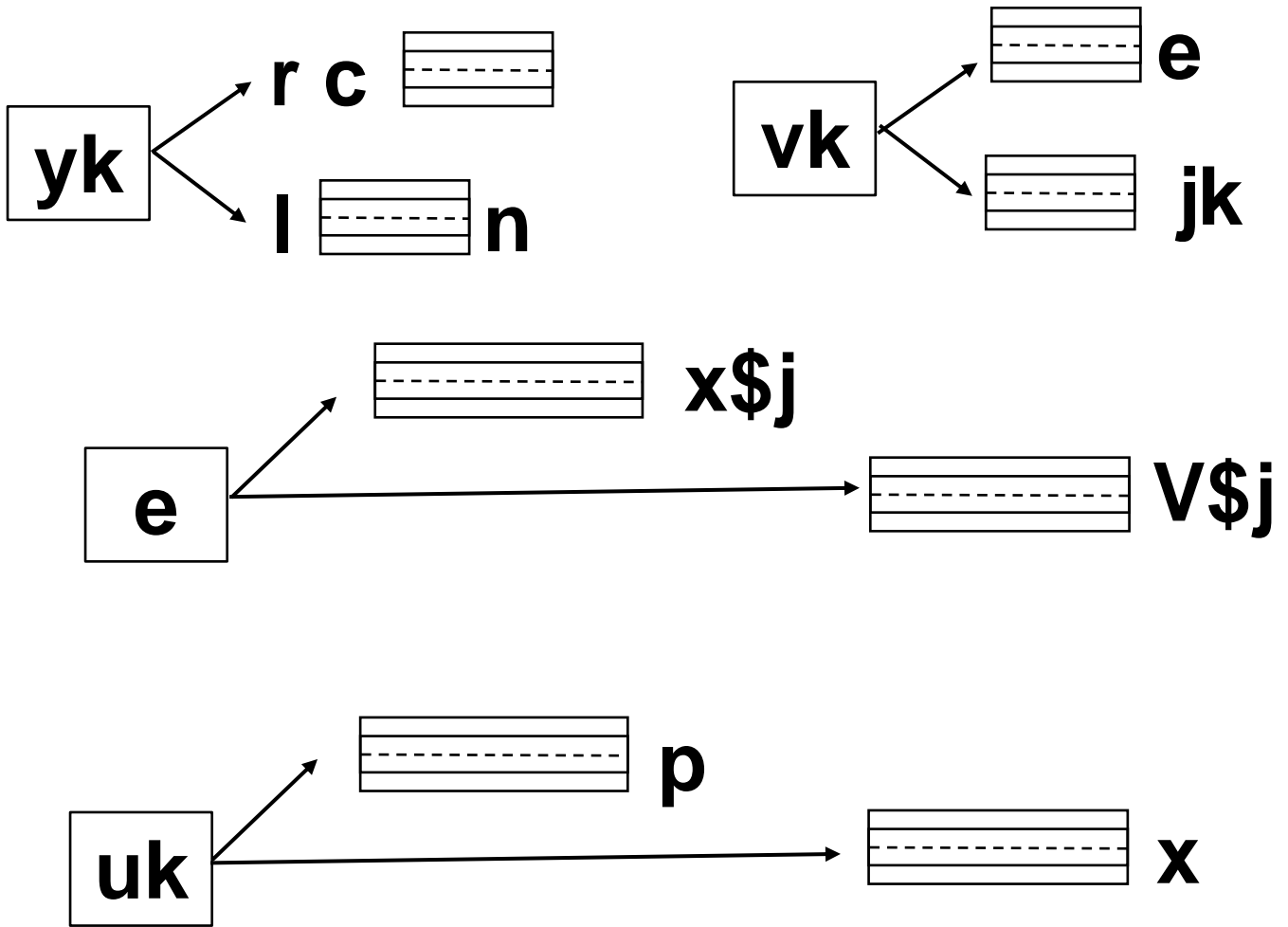

lgh ek=k yxkvks & $\frac{1}{4}$ *vk* o *b* $\frac{1}{2}$

uka a aaj;y

“ka a aa uokj

v a aale y

p a aaoy

a aa xVkj

a aa drkc

a aa V a aa d;k

a aac a aaV;k

Put the correct signs (>) (=) (<)

7 6

16 32

50 35

8 8

49 46

1 0

37 16

18 21

12 5

11 11

31 31

14 15

Count & Write :

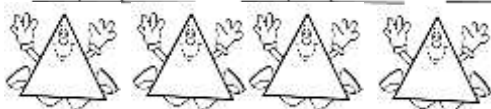
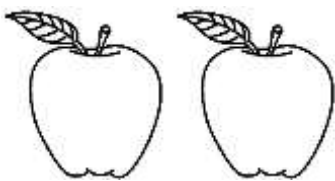
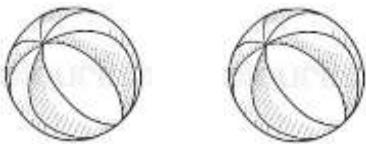

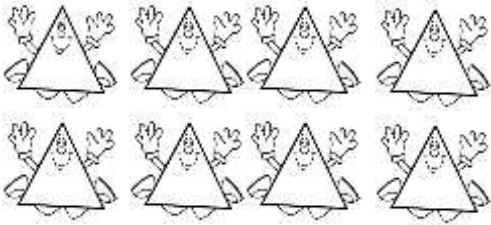



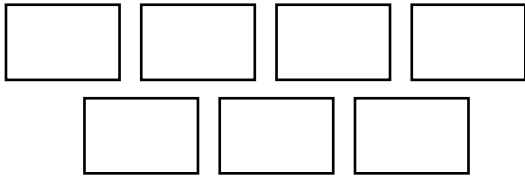

Complete the sequence (Before, After, Between) :

	4	
--	---	--

		9
--	--	---

3		
---	--	--

	7	
--	---	--

	12	
--	----	--

		16
--	--	----

11		
----	--	--

	21	
--	----	--

	25	
--	----	--

		20
--	--	----

1		
---	--	--

		5
--	--	---

Learn and write :

$2 \times 1 = \underline{\hspace{2cm}}$

$3 \times 1 = \underline{\hspace{2cm}}$

$2 \times 2 = \underline{\hspace{2cm}}$

$3 \times 2 = \underline{\hspace{2cm}}$

$2 \times 3 = \underline{\hspace{2cm}}$

$3 \times 3 = \underline{\hspace{2cm}}$

$2 \times 4 = \underline{\hspace{2cm}}$

$3 \times 4 = \underline{\hspace{2cm}}$

$2 \times 5 = \underline{\hspace{2cm}}$

$3 \times 5 = \underline{\hspace{2cm}}$

$2 \times 6 = \underline{\hspace{2cm}}$

$3 \times 6 = \underline{\hspace{2cm}}$

$2 \times 7 = \underline{\hspace{2cm}}$

$3 \times 7 = \underline{\hspace{2cm}}$

$2 \times 8 = \underline{\hspace{2cm}}$

$3 \times 8 = \underline{\hspace{2cm}}$

$2 \times 9 = \underline{\hspace{2cm}}$

$3 \times 9 = \underline{\hspace{2cm}}$

$2 \times 10 = \underline{\hspace{2cm}}$

$3 \times 10 = \underline{\hspace{2cm}}$

Rearrange the jumbled words :

1. C T H A C _____

2. U A S V _____

3. N A G M O _____

4. B I B T A R _____

5. H E T R F A _____

6. P L H O I N D _____

7. R L S T O B E _____

8. W R M S O L I K _____

9. OPTSOUC _____

10. ELAS _____

- **Draw/paste picture of your favourite season and write two lines about it.**

Practice it

A B C D

E F G H

I J K L

M N O P

Q R S T

U V W X

Y Z

Practice it

a b c d

e f g h

i j k l

m n o p

q r s t

u v w x

y z

Practice it

Take bath everyday.

सुलेख

अगर साल भर पढ़ रहे तब हल सभी सवाल।

इसके बिना नहीं गले किसी तरह से दाल।

अपने को मानो नहीं किसी तरह कमजोर।

पढ़ लिख श्रम करते रहो बिना मचाए शौर।

सुलेख

पैड़ सभी को दे रहे जीवन का वरदाना

इसीलिए इन पर नही कभी कुल्हाड़ी ताना

वृक्ष सदा संसार में जीवन के आधार।

वृक्ष लगाना जग भला सह कर कष्ट हजार।